

Passport Presentation

action

- FADE IN text – Avantrust Passport
- FADE IN visual of Passport main screen

frame example

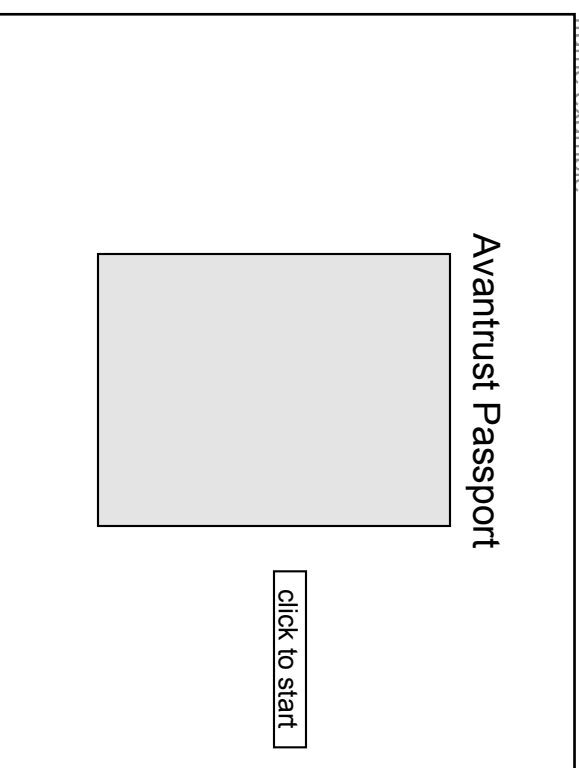

voiceover

audio

VO only

Passport Presentation

1 – The Marketplace

action

- Visual – diverse people in a business context networked together, with Passport as the central connection
- Animation – light/data paths tracing connections and transfer between people
- (People do not directly connect; all paths are instead shown passing through Passport)

frame example

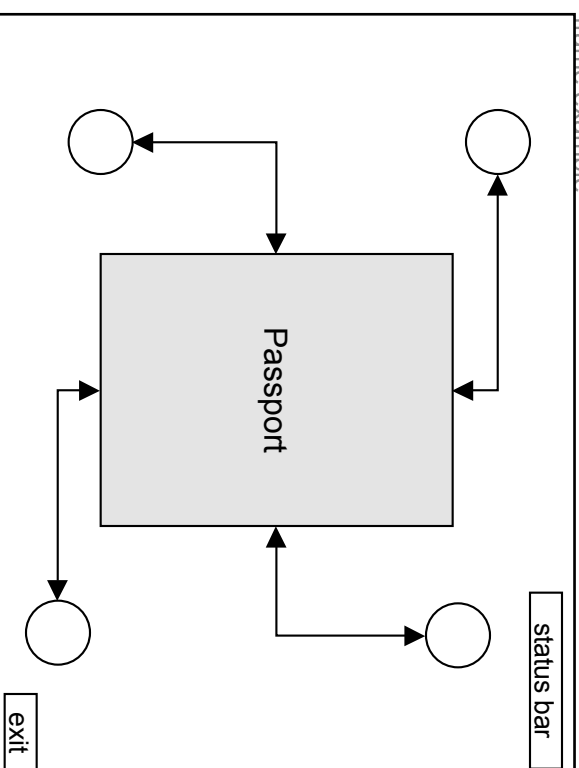

voiceover

Every day, marketplace environments bring fragmented industries together. Through this new eBusiness channel, parties can transact with vendors that would have previously remained invisible.

audio

VO only

Passport Presentation

1 – The Marketplace

action

- Animation – light/data paths interrupted and/or slower than before

frame example

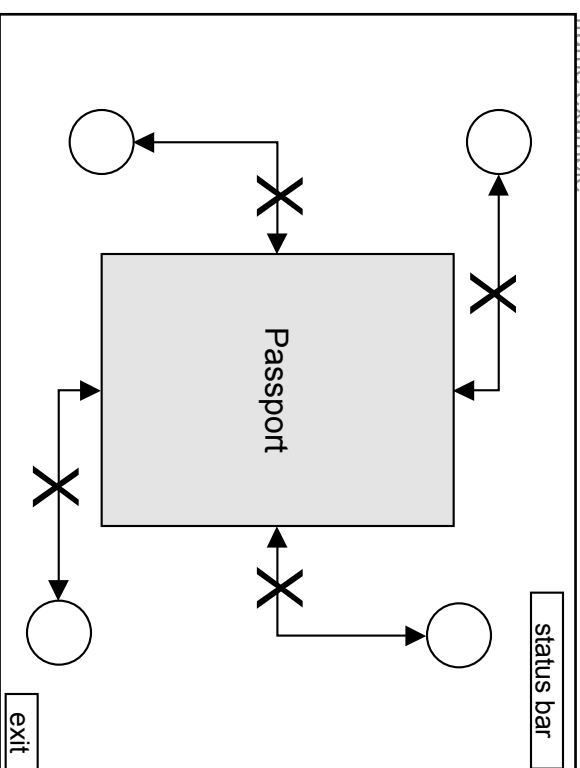

audio

VO only

voiceover

One great challenge exists in this environment – the **ability** to verify the **identity** and **credit worthiness** of trading partners.

Passport Presentation

1 – The Marketplace

action

- FADE BACK transaction elements
- FADE IN text – Instant, Current, Reliable

frame example

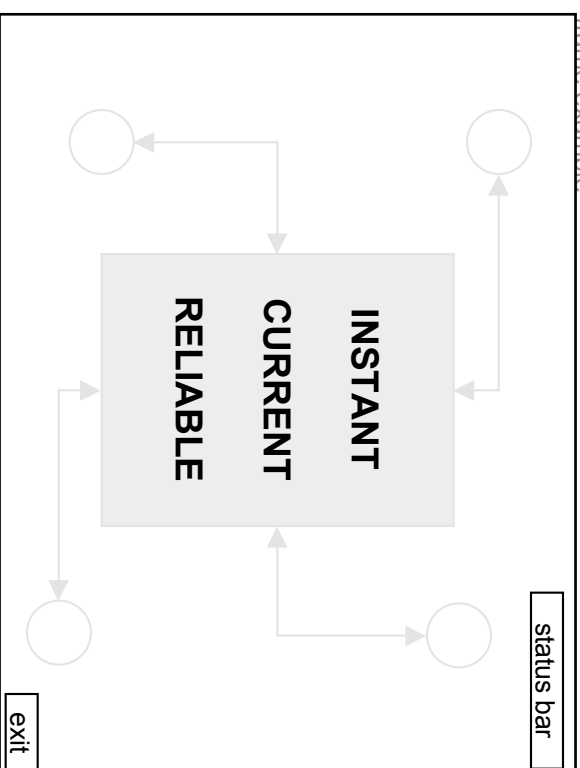

voiceover

To mitigate the risk of unknown parties transacting online, exchanges need to offer instant, current, and reliable information to their participants. **This** information is then used to evaluate buy/sell decisions and complete transactions.

audio

VO only

Passport Presentation

2 – What is Passport?

- action
- FADE OUT previous transaction elements and Passport
 - FADE IN Avantrust logo
 - FADE IN text – B2B, Insurance, Technology, Information

frame example

status bar

INSURANCE **B2B**

avantrust

TECHNOLOGY **INFORMATION**

exit

voiceover

Avantrust (ah-vahn-**trust**), a leading provider of risk management products and services, integrates information, insurance, and technology for the business-to-business exchange community.

audio

VO only

Passport Presentation

2 – What is Passport?

action

- FADE OUT Avantrust logo
- FADE IN Passport
- FADE OUT ALL

frame example

status bar

exit

audio

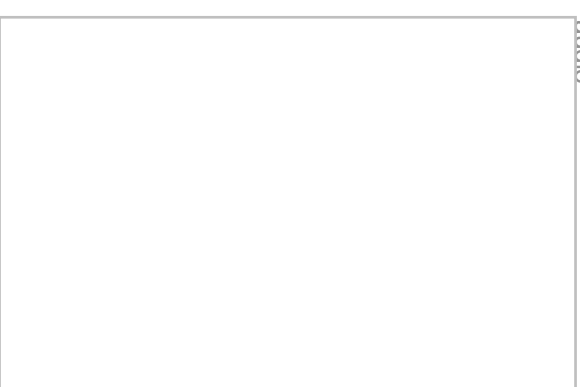

voiceover

The Avantrust Passport is a **new** and **innovative** offering that allows buyers and sellers to **transact** in marketplaces with **confidence**.

Passport Presentation

3 – Accessing Passport

action

- FADE IN marketplace page
- Animation – Avantrust Passport link placed on page
- Animation – cursor activates Passport link
- Animation – Passport pops up in foreground

frame example

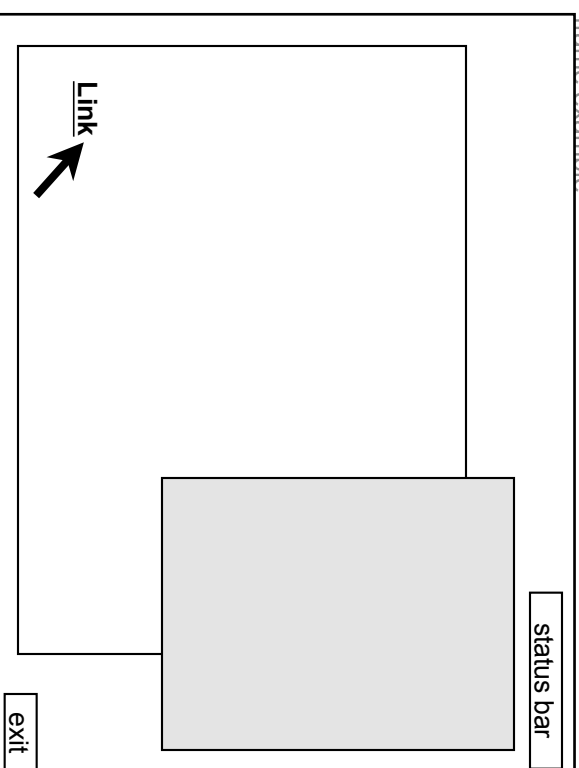

audio

- Click SFX sync with link activation

voiceover

A **marketplace** can begin incorporating Avantrust Passport into the transaction process by placing a Passport link on purchasing pages.
(click SFX)
Clicking on this link opens the Passport in a pop-up browser window. Here a buyer or seller can access identity profiles as well as business, exchange, and credit information.

Passport Presentation

3 – Accessing Passport

action

- Animation – cursor activates Log On link

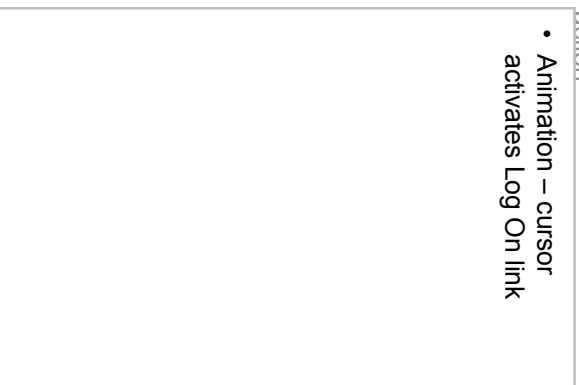

frame example

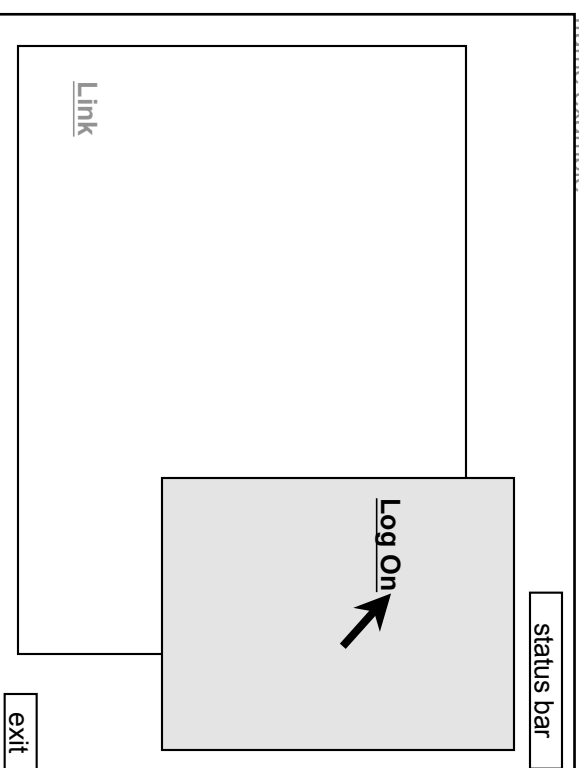

voiceover

Marketplace members can activate their Passports by first **registering** at Avantrust.
Other members can then be accessed...

audio

- Click SFX sync with link activation

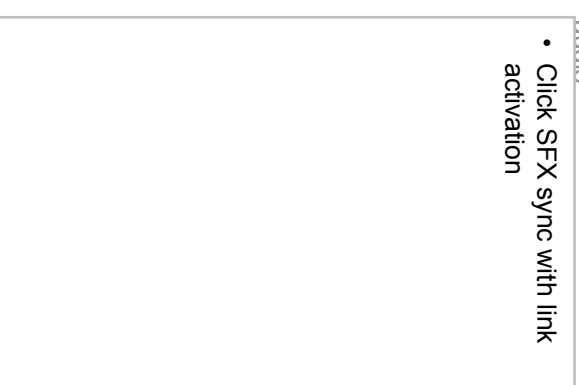

Passport Presentation

4 – Using Passport

action

- Animation – simulated entry of name and password
- Animation – cursor activates Enter link

frame example

status bar

Link

Log On: user

Password: pass

exit

voiceover

...by logging in.

audio

- Click SFX sync with link activation

Passport Presentation

4 – Using Passport

action

- Search screen appears
- Animation – simulated entry of search fields
- Animation – cursor activates Search link

frame example

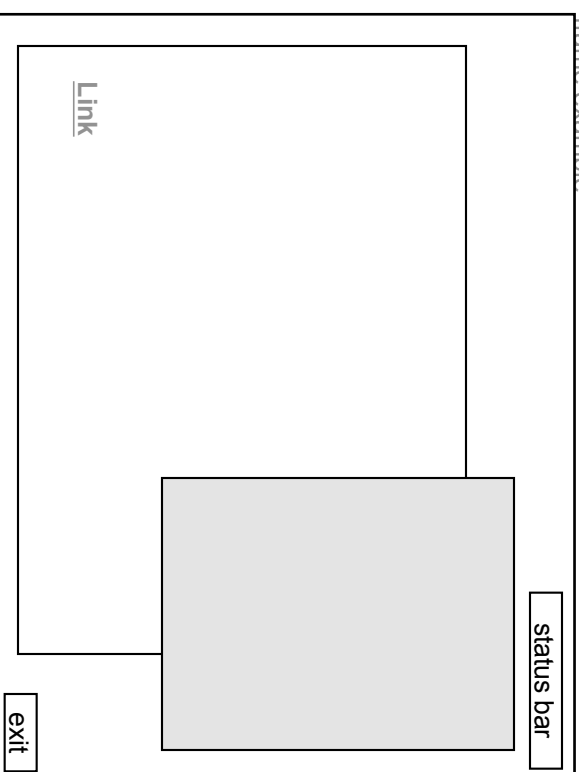

audio

- Click SFX sync with link activation

voiceover

Passports belonging to potential trading partners may now be located and accessed.

Passport Presentation

4 – Using Passport

action

- Search results page appears
- Animation – cursor moves across four main tabs, then selects Profile view
- Profile page appears
- Animation – cursor moves and highlights section on AV date

frame example

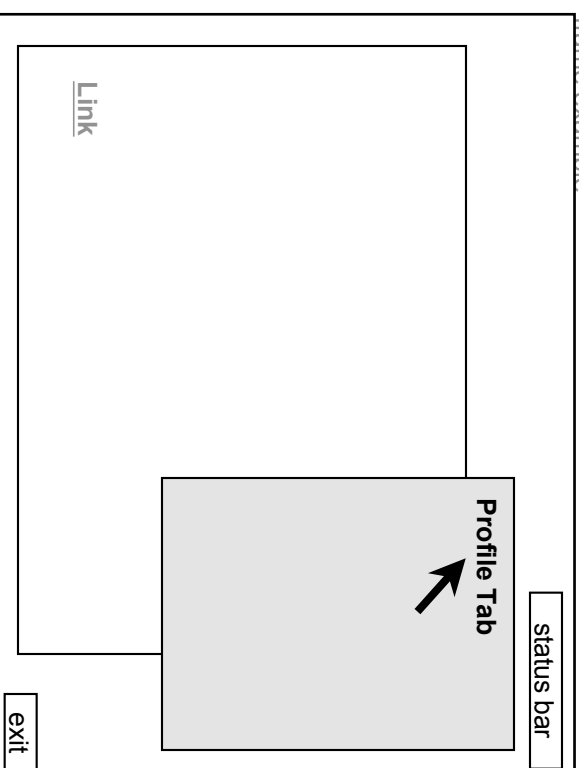

audio

- Click SFX sync with tab activation

voiceover

Each Passport contains **four** views – Profile, Exchange, Business, and Credit.
The Profile view includes the AV date, the most recent ID check performed on this business or individual by a world-class verification company.

Passport Presentation

4 – Using Passport

action

- Animation – cursor selects Exchange tab
- Animation – Exchange view appears
- Animation – cursor moves and highlights referenced information

frame example

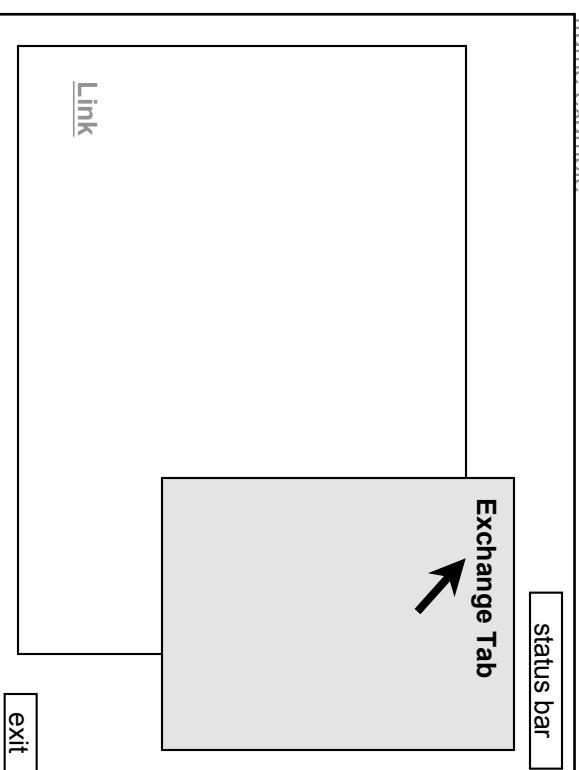

audio

- Click SFX sync with tab activation

voiceover

The Exchange view highlights information regarding exchange security. This includes whether the exchange has netAdvantage Web site Insurance, Cargo Insurance, and if a security assessment has been completed.

Passport Presentation

4 – Using Passport

action

- Animation – cursor selects Business tab
- Animation – Business view appears
- Animation – cursor moves and highlights referenced information

frame example

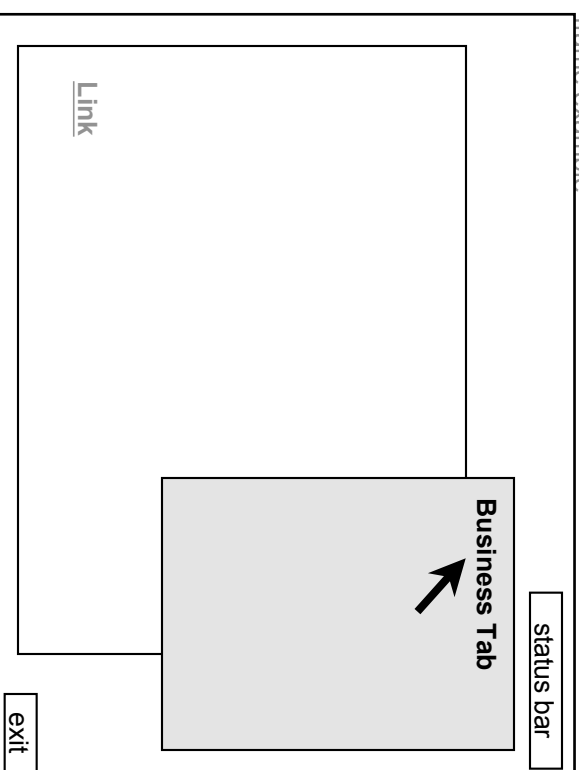

audio

- Click SFX sync with tab activation

voiceover

The Business view provides additional information required to complete the transaction, including company ownership, employee headcount, financial stress score, and SIC code. Essentially, this view provides a **snapshot** of a company's overall health and operational strength.
A nominal fee is charged to view this information.

Passport Presentation

4 – Using Passport

action

- Animation – cursor selects Credit tab
- Animation – Credit view appears
- Animation – cursor moves and highlights referenced information

frame example

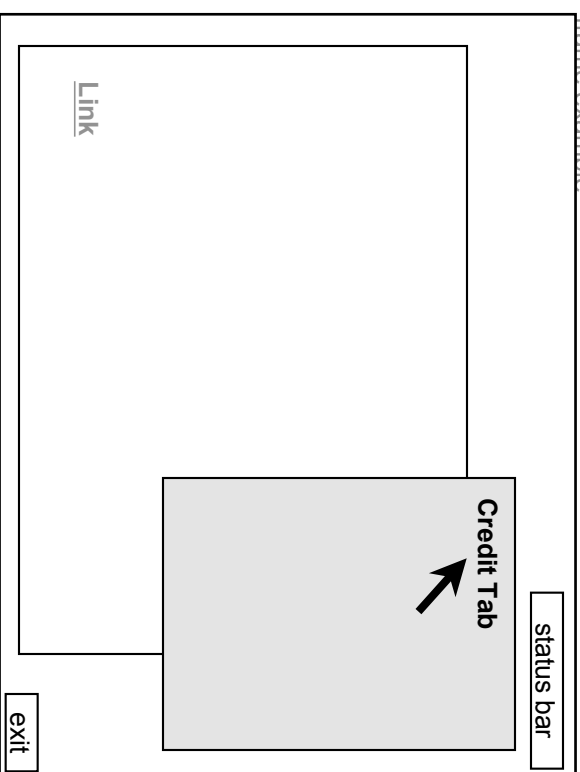

audio

- Click SFX sync with tab activation

voiceover

For non-insured sites, the Credit view provides information regarding a company's rating, recommended customer limit, recommended maximum terms of payment, and PAYDEX score. This information helps a seller determine whether a potential buyer has a business **profile required** to make the desired transaction.
Once again, a nominal fee is charged to view this information.

Passport Presentation

4 – Using Passport

action

- Animation – tab changes to insured version
- Animation – cursor moves and highlights referenced information

frame example

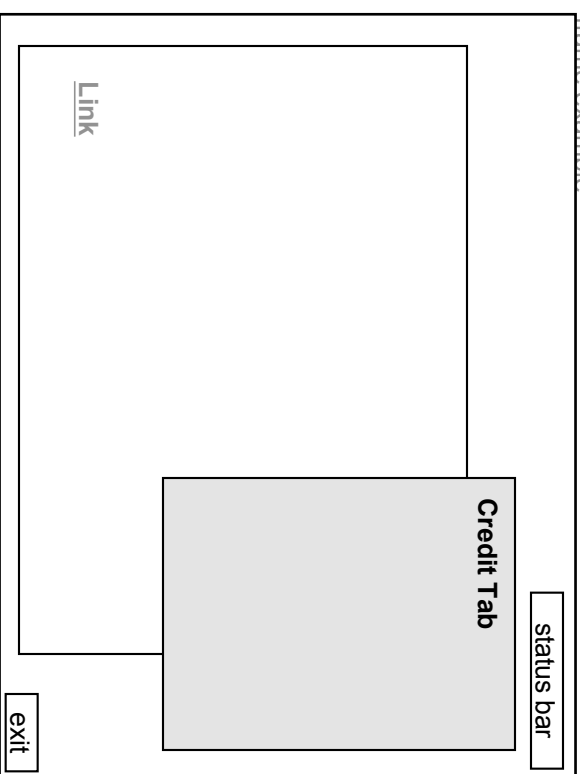

voiceover

Passport also offers a special **credit view** for **insured sites**, presenting real-time information including approved customer limit, available insurable capacity, approved maximum terms of payment, rating, and PAYDEX score.
A nominal fee is once again charged to view this information.

audio

- Click SFX sync with tab activation

Passport Presentation

4 – Using Passport

action

- Animation – cursor selects View My Passport link
- Animation – My Passport view appears
- Animation – cursor moves and highlights referenced information

frame example

status bar

View My Passport

Link

exit

voiceover

Selecting the “View My Passport” link displays the current user’s profile as seen by other Avatrust members. This view allows the user to review and verify accuracy of listed business information, credit ratings, and other information.

audio

- Click SFX sync with tab activation

Passport Presentation

4 – Using Passport

action

- Animation – cursor selects Preferences link
- Animation – Preferences view appears
- Animation – cursor moves and highlights referenced information

frame example

status bar

View/Edit Preferences

Link

exit

voiceover

Members may restrict access to profile information by selecting View/Edit Preferences. Fields including general contact information, email address, marketplace ID, and DUNS number entries may be displayed or hidden.

audio

- Click SFX sync with tab activation

Passport Presentation

4 – Using Passport

- action
- Animation – cursor selects Edit Profile link
 - Animation – Edit Profile view appears
 - Animation – cursor moves and highlights referenced information

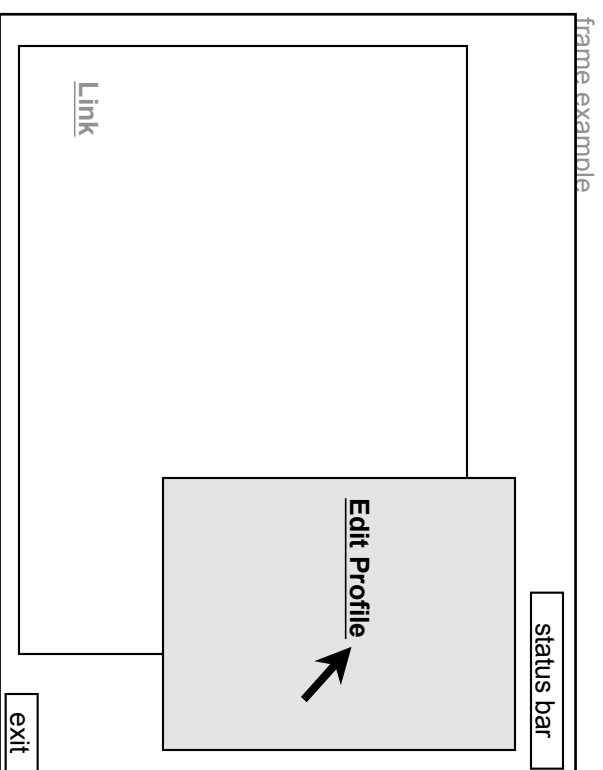

voiceover

Members may also select Edit Profile and make adjustments to their Passport profile by submitting a dispute request.

- audio
- Click SFX sync with tab activation

Passport Presentation

5 – Other Passport Features

action

- Animation – cursor selects Cargo link
- Animation – relevant AIG page appears in background

frame example

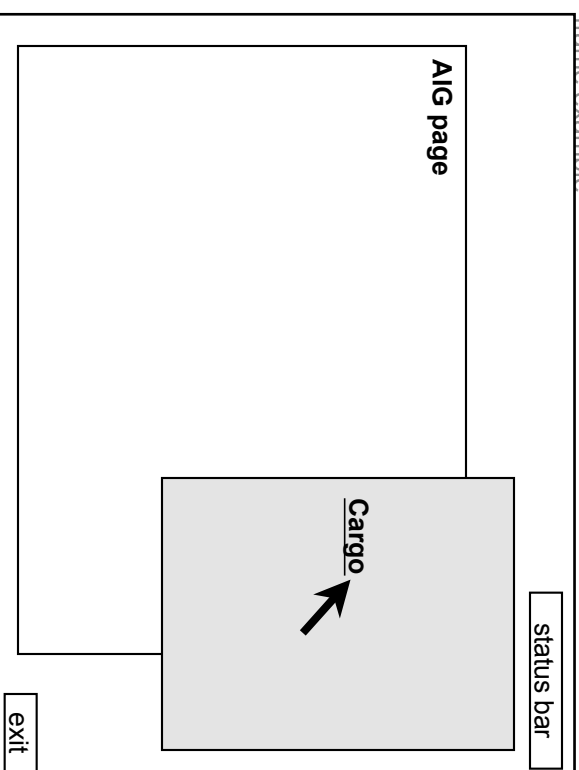

audio

- Click SFX sync with tab activation

voiceover

Passport also provides **single-click access** to the full suite of Avantrust products and services at any time. Members may access applications for Cargo Insurance, Inspection Services, Credit Insurance, and Web Site Insurance.
These solutions **further reduce** the marketplace trading risk, allowing buyers and sellers to **transact with increased confidence**.

Passport Presentation

5 – Other Passport Features

action

- Animation – Passport window is closed
- Animation – Log On process recap, then Passport returns to previous screen

frame example

The diagram shows a rectangular frame. Inside, there is a large grey rectangle labeled 'Passport' with an 'X' icon and an arrow pointing to it. To the left of the 'Passport' window is a smaller rectangle labeled 'Link'. At the bottom right of the frame is a small rectangle labeled 'exit'. At the top right of the frame is a rectangle labeled 'status bar'.

voiceover

The marketplace window and purchasing session are always **available** while using Passport. The Passport window may also be closed at **any time** without interrupting the transaction.

audio

- Click SFX sync with tab activations

Passport Presentation

action

- FADE OUT all elements

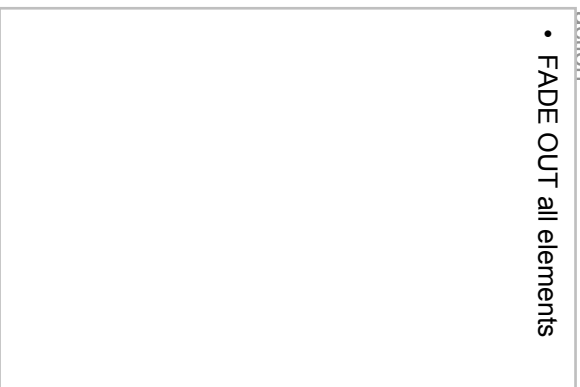

frame example

status bar

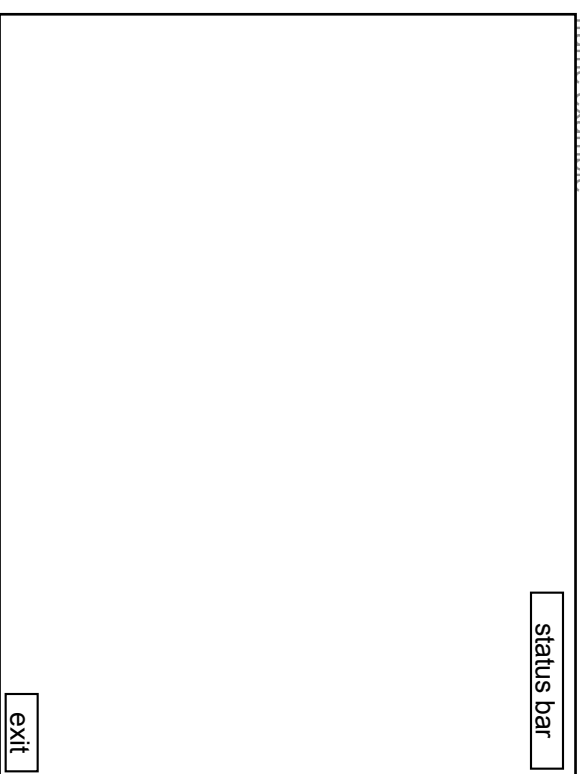

exit

voiceover



audio

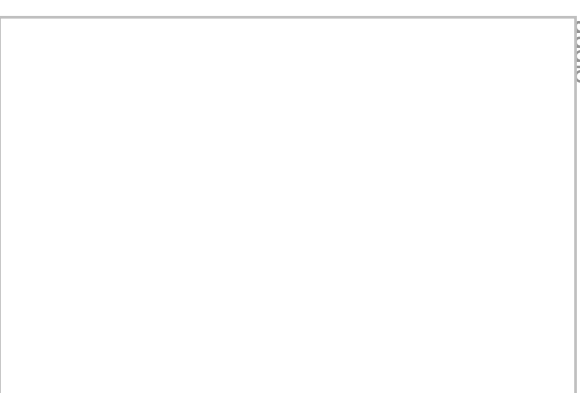

Passport Presentation

6 – Things to Remember

action

- Animation – benefits listed onscreen

frame example

- Passport
- Is a new product offered by Avatrust
 - Increases liquidity at marketplaces
 - Provides credit and identity information from leading information service and risk management companies to assist in making purchasing decisions
 - Offers quick access to additional Avatrust products and services that complement the purchasing process

status bar

exit

audio

voiceover

Passport

- Is a **new** product offered by **Avatrust**;
- It **increases liquidity** at marketplaces;
- It provides **credit and identity information** from leading information service and risk management companies to **assist** in making purchasing **decisions**;
- And offers **quick access** to additional Avatrust products and services that complement the purchasing process

Passport Presentation

- action
- FADE IN text – Avantrust Passport
 - FADE IN visual of Passport main screen
 - Replay Presentation button appears

